

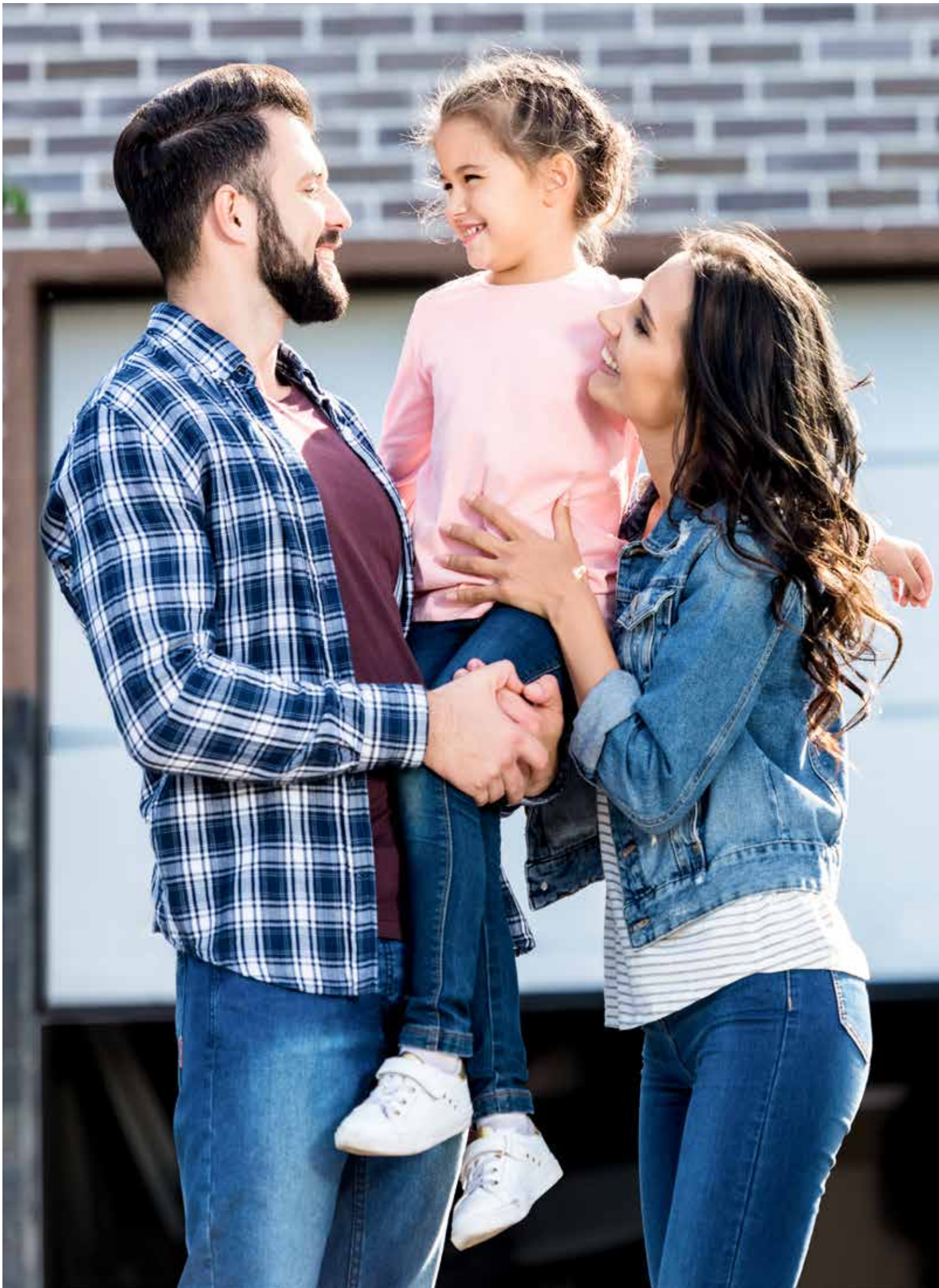

GARAGE DOORS

by **RYTERNA**





Content:

6	RIB
8	MIDRIB
12	FLUSH
14	GEORGIAN (CASSETTE)
16	SLICK
20	SLICK PLUS
22	MACRORIB & MICRORIB
24	TOPRIB
26	SLIM LINE
28	OKOUME
30	ALUMAX
32	RETRO
34	SIDE HINGED GARAGE DOORS
40	SIDE DOORS
44	WICKET DOORS
46	DECOR APPLIQUÉS
48	FULL VISION PANELS
49	STAINLESS STEEL WINDOWS
49	PVC DOUBLE GLAZED WINDOWS
51	HARDWARE TYPE R40
53	HARDWARE TYPE TL
54	FASCIA PANELS AND FRAMES
55	ACCESSORIES
56	THE SIDE SLIDING SECTIONAL DOOR
60	CUSTOM MADE DOORS
62	NON-STANDARD SOLUTIONS
62	MATCHING DESIGN





Sectional door TL Alumax.
Entrance door RD 80 custom design.



Unlimited creativity
Think outside the box



Rib



Horizontal ribs every 10 cm give this door a light robust appearance. This is a contemporary door that looks good in any architectural setting. 'Rib' design doors are often combined with full-vision aluminium panels available in any RAL colour. The Wood Rib style doors come with woodgrain embossed surface. 'Rib' design panels are best for extra size doors – they can be made up to 10 metres wide.



Other painted colours similar to RAL palette



Woodgrain

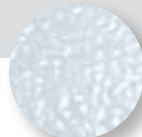

Stucco

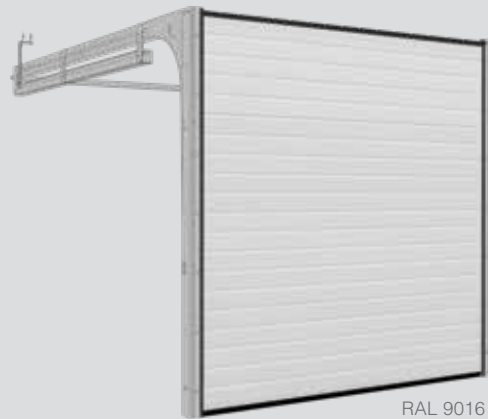

RAL 9016



RAL 8017

Track type R40 UM/ SM/ TM, TL STD/ LHR FM/ LHR RM



Midrib



'Midrib' design doors, grooved in the middle of each panel, give the impression of solid timber boards. This is a popular design all over Europe. 'Midrib' panels are available in woodgrain, stucco and smooth surfaces in standard white RAL 9016 or any other RAL colour. The Wood Midrib design doors come with a smooth surface and natural wood looking UV proof Light Oak, Golden Oak, Dark Oak, Old Oak, Mahogany (Rosewood) or Winchester finish.



Other painted colours similar to RAL palette



Smooth



Woodgrain



Stucco



Light Oak smooth



Golden Oak smooth



Old Oak smooth



Dark Oak smooth

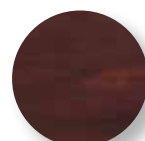

Mahogany smooth



Winchester smooth

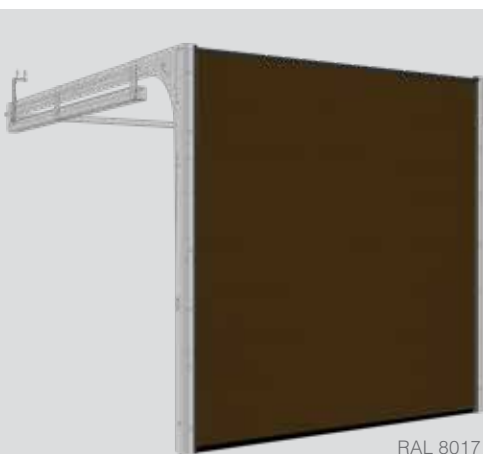

RAL 8017

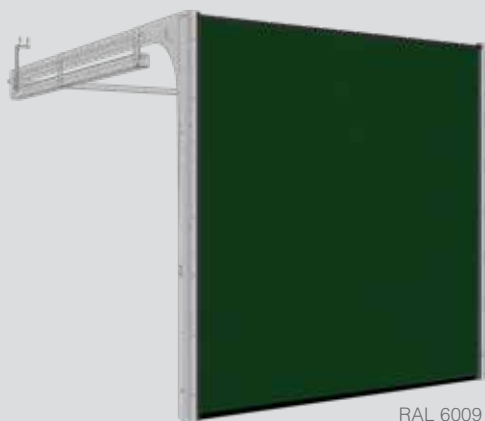

RAL 6009

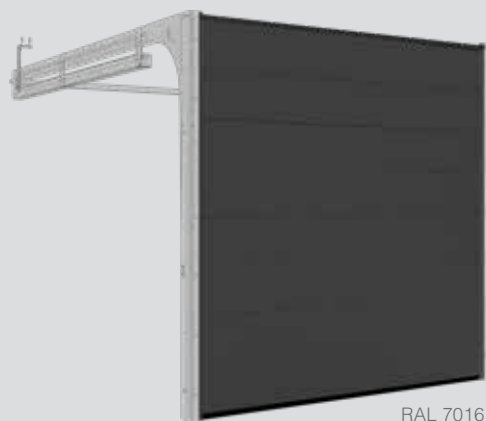

RAL 7016

Track type R40 UM/ SM/ TM, TL STD/ LHR FM/ LHR RM



Sectional doors: TL Midrib Old Oak.





Flush



'Flush' design door with its woodgrain or stucco embossed surfaces perfectly matches with both heritage and modern houses. The look is subtle and understated especially when combined with stainless steel windows. 'Flush' design doors are available in standard RAL 9016 white or any RAL colour.



Other painted colours similar to RAL palette



Woodgrain



Stucco



RAL 9016

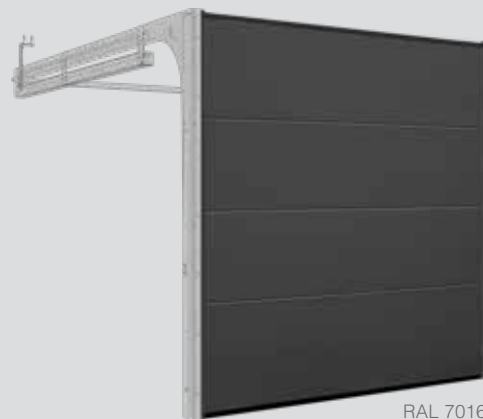

RAL 7016

Track type R40 UM/ SM/ TM, TL STD/ LHR FM/ LHR RM



Georgian (Cassette)



This door has stylish 'Georgian' type rectangular panels beautifully sculptured with crisp lines and details on the outer surface. 'Georgian' design perfectly matches with heritage and country style houses.



Other painted colours similar to RAL palette



RAL 9016 woodgrain



Golden Oak woodgrain



RAL 9016



Golden Oak

Track type R40 SM/ UM/ TM, LHR FM/ TL STD/ LHR RM



Slick



The top range 'Slick' design door offers a totally flat and smooth panel surface. It is great for combining with stainless steel windows or appliques. Metallic or 'Pearl effect' finish will make your door simply irresistible.

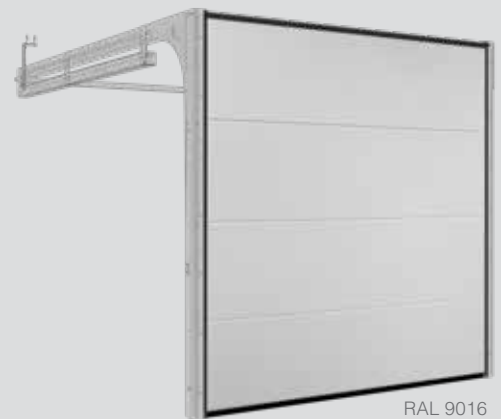

Other painted colours RAL pearl colours similar to RAL palette

Smooth



RAL 9006

RAL 7016

RAL 9004

Track type R40 SM/ UM/ TM, LHR FM/ TL STD/ LHR RM



Sectional doors: TL Slick RAL 7016.
Entrance door RD80 design 303.





Slick Plus - Exclusive Coatings

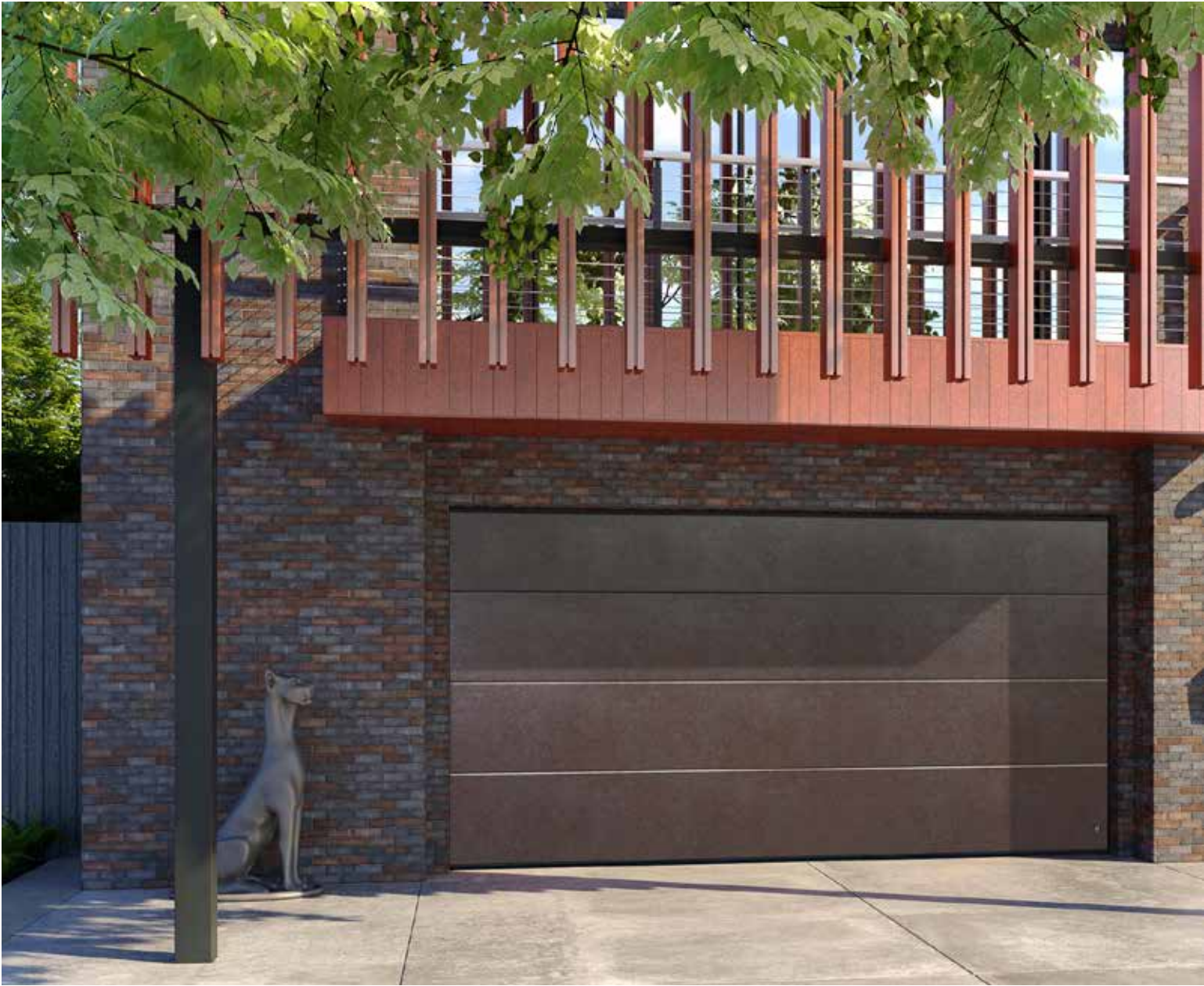

Stainless Steel



Metallic Anthracite Grey



Copper

Exclusively laminated.
Smooth surface doors with an impressive Stainless Steel, Anthracite Grey Metallic, Copper, 3D Grey, 3D White, Linea finish.



Track type R40 SM/ UM/ TM, LHR FM/ TL STD/ LHR RM



Macrorib & Microrib



The surface of macrorib door is stucco embossed and formed in soft waves every 20 mm. An attractive modern style door, suitable for both residential and commercial properties. 'Macrorib' doors come in standard RAL 9016 or in any other RAL colour.

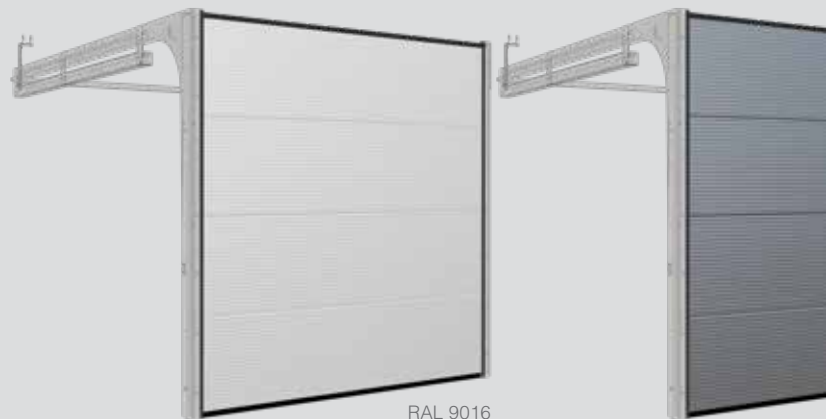

RAL 9016



Other painted colours similar to RAL palette



Stucco 20 mm rippled surface



RAL 9016

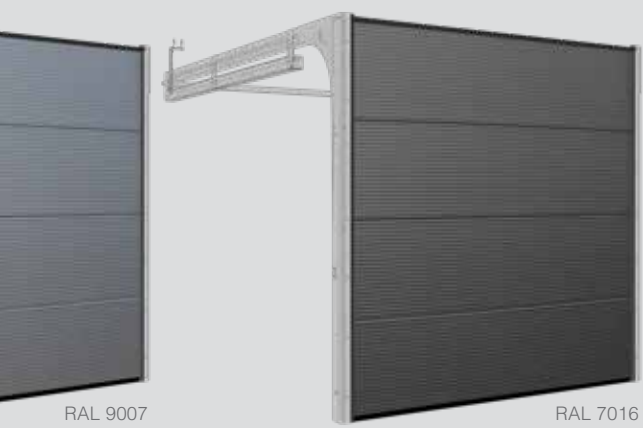

RAL 9007

RAL 7016

Track type R40 SM/ UM/TM, LHR FM/ TL STD/ LHR RM

The strength of this modern design door lies in its exceptional smooth surface, slightly waving every 10 mm. These unique panels can be combined with stainless steel windows for a creative and practical appearance. 'Microrib' doors come in standard RAL 9016 white or painted in any RAL colour. Metallic finish on Microrib door creates stunning effect.



Smooth
10 mm rippled
surface



TopRib - Modest Elegance



Double groove design is one of the most noticeable designs on the market. Three double lines dividing door plane make this door outstanding among similar products.



Other painted colours similar to RAL palette



RAL pearl colours similar to RAL palette



Smooth

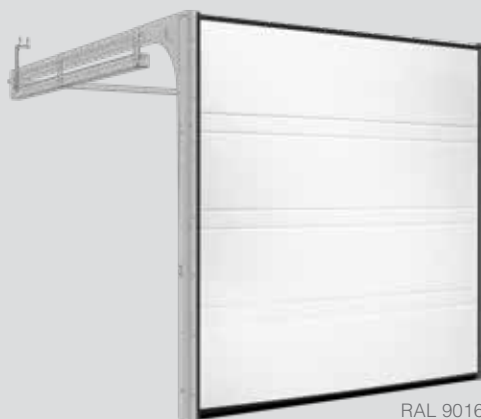
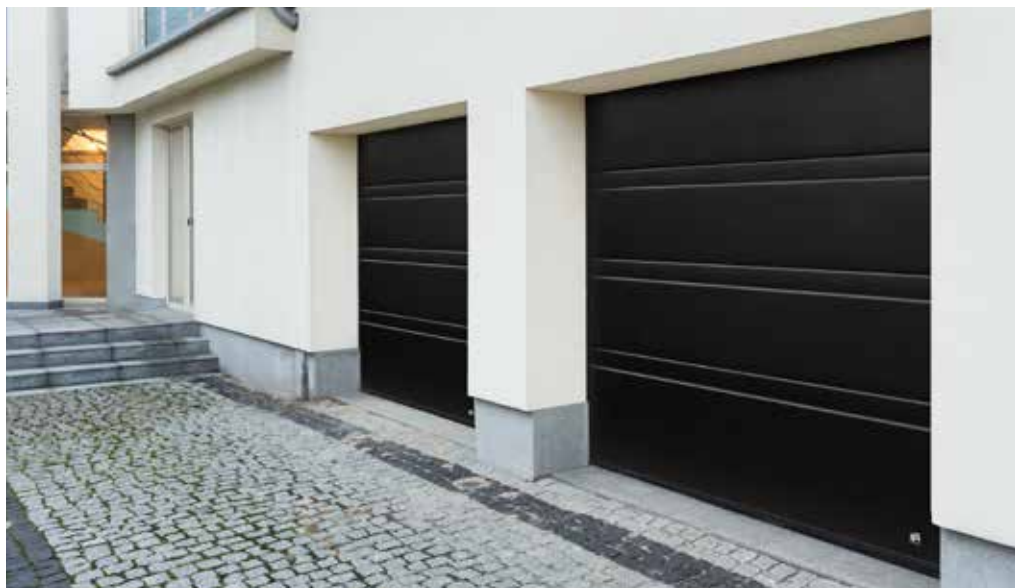

RAL 9016



RAL 7016

Track type R40 SM/ UM/ TM, LHR FM/ TL STD/ LHR RM



Slim Line

Combination of Slick panels and narrow glazed aluminum sections gives this door a very special look. We call this door design - 'Slim Line'.

Various glazing types are available. Window height may vary from 5 to 10 cm.

Glazing with LED stripe lights inside make the door look splendid day & night.

Continuous glazing - up to 3 meters.







Okoume - Create Your Own Style

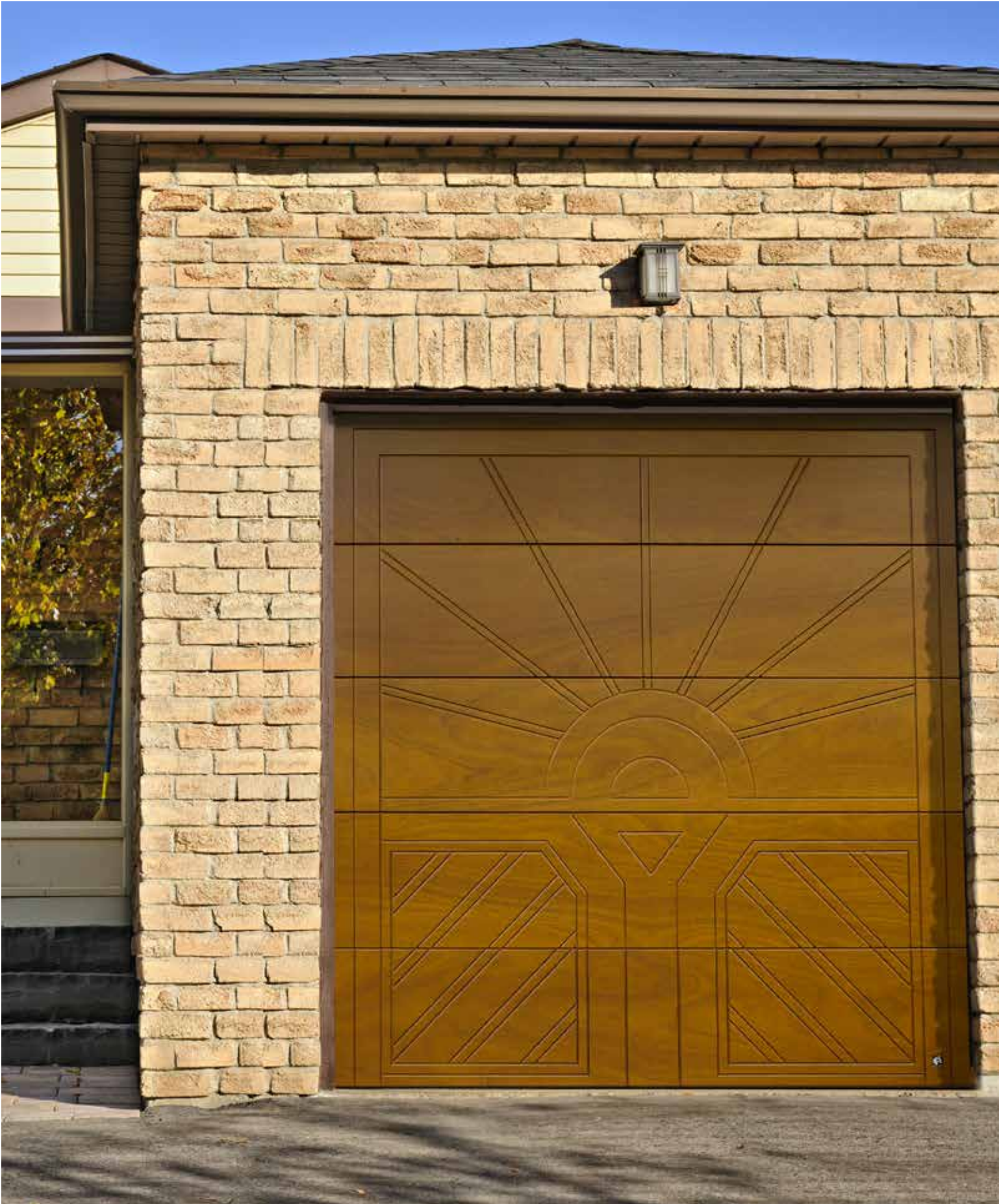

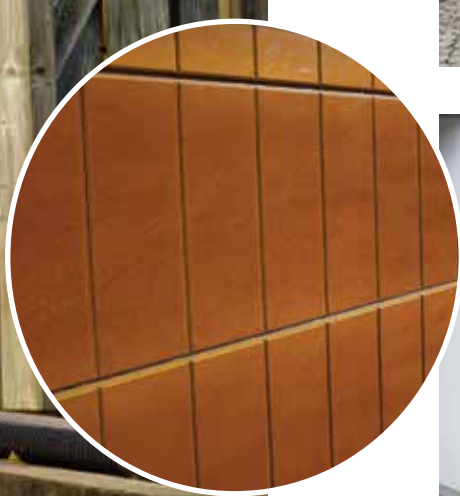
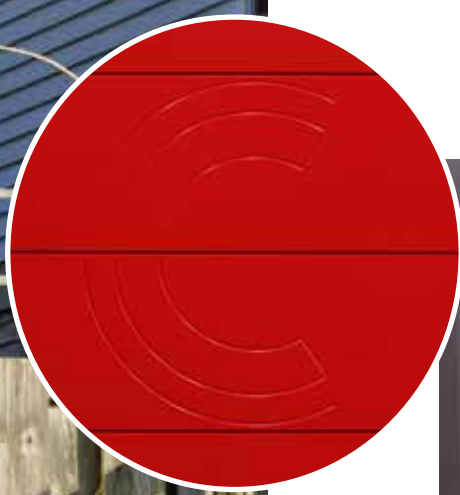

Standard door panels clad with 12 or 18 mm thick okoume plywood. Extremely water resistant okoume hardwood is used for shipbuilding. By carving or milling okoume layer we can recreate different motifs, patterns and ornaments. Can be varnished in different shades or painted in almost all colours. Combination with windows and specific design will fit most demanding conservation area requirements. Two layers of primer and three layers of varnish or paint give long lasting protection from the elements. Available on all types of garage doors.





Alumax - Unlimited Space For Creativity



Sectional garage door Alumax custom design RAL.
Entrance door RD80 custom design.



Cutting edge technology in garage door design. Unlimited space for creativity!

Absolutely matching entrance and garage door designs. Sectional door panels clad with 2.5 mm aluminium sheets milled and painted any RAL colour including metallic finish and decorated with inlays can create a real piece of art.





Retro - Match the Heritage

The 'Retro' door is made to match the old building style.

Ribbed sections decorated with planks in woodgrain. Fitted with old style metal hinges and handles. Custom design available on request.



Retro S



Retro X



Retro H



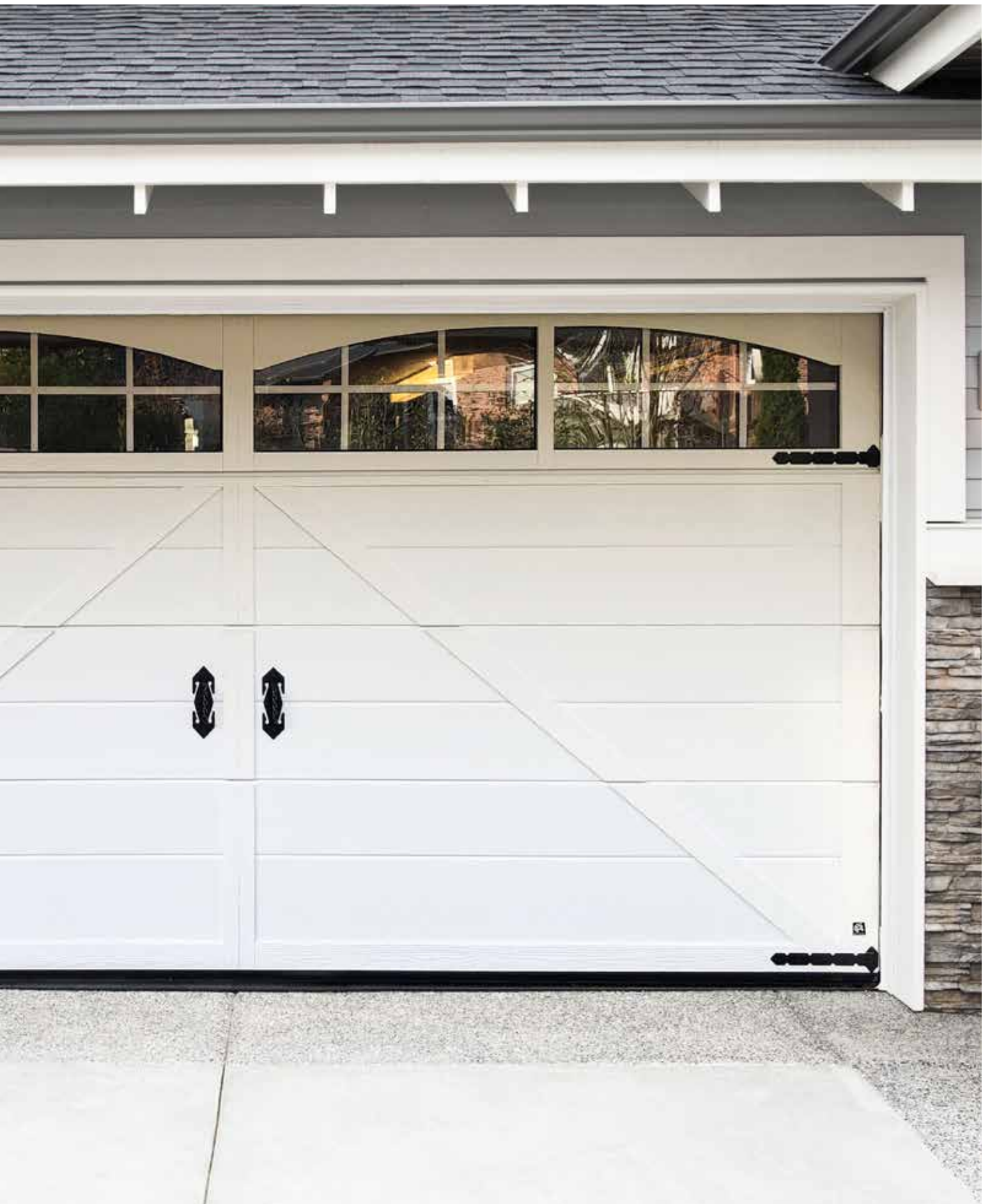



Side Hinged Garage Doors



Made to measure up to 3 metres wide and 2.5 metre high. Insulated, robust, compatible with most garage door openers. All designs, colours and panel models are available. You can choose options like windows, glazed panels, stainless metal appliqués or even pet-flap. Door can be left or right handing and custom split. Handle standard colours: black, white, aluminium. As additional option, handle can be finished in door colour.



Other painted colours similar to RAL palette



Smooth



Woodgrain



Stucco







Espagnolette lock - makes second leaf opening and closing effortless.



Door stays



Hinge bolts

Stainless steel cover for S5 threshold





Side Hinged doors SH2 Slick RAL 9007 with vertical glazing.



Ryterna Side Hinged Garage doors - Modern take on an old style.



Side doors



Ryterna manufacture made to measure side doors to match garage door design. Insulated Ryterna side doors are made of insulated 40 mm thick panels with all perimeter rubber sealing. Uniform design and layout brings consistency to house façade.



Standard frame



Frame with mouldings



Easy fixing to side walls

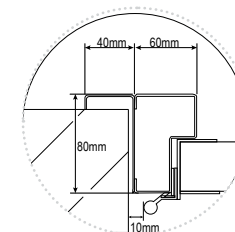

Frame dimensions



Handle standard colours:
aluminium, black, white.
Other colours upon request.



Hinge bolts







Wicket doors



Wicket door are very convenient option if garage door space is used for a hobby or as a utility room. Left or right handing, width up to 1.2 m and low threshold can turn your garage into a handy space.



Low threshold pass door



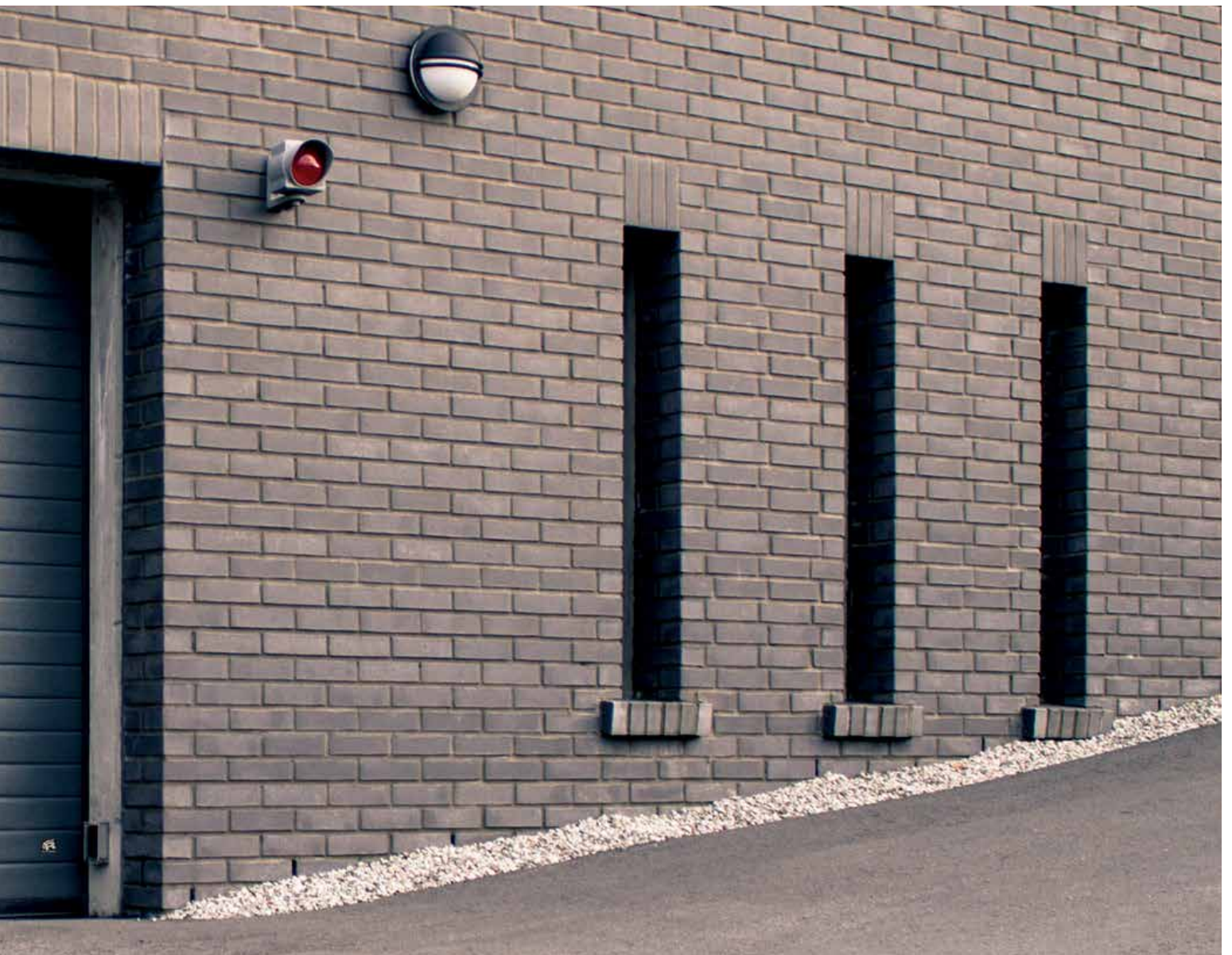



Decor appliqués

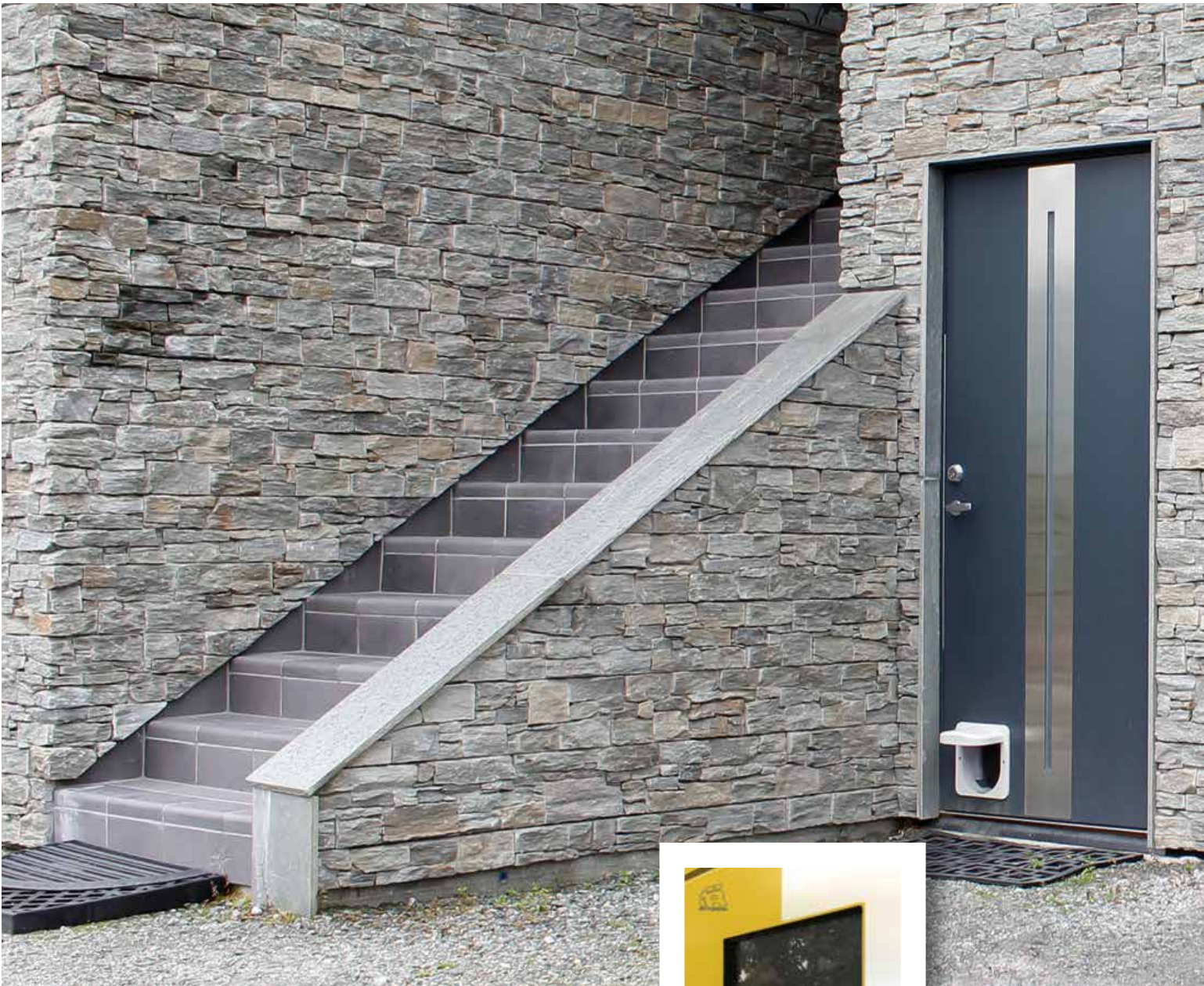

For more options see
DESIGN catalogue

We offer wide range of stainless metal appliqués. Brushed metal effect or painted any RAL colour. Appliqués will suit most demanding design requirements. If you can't find what you like an option could be your personal design appliqué. Just send a picture or drawing and we will replicate it on your door.



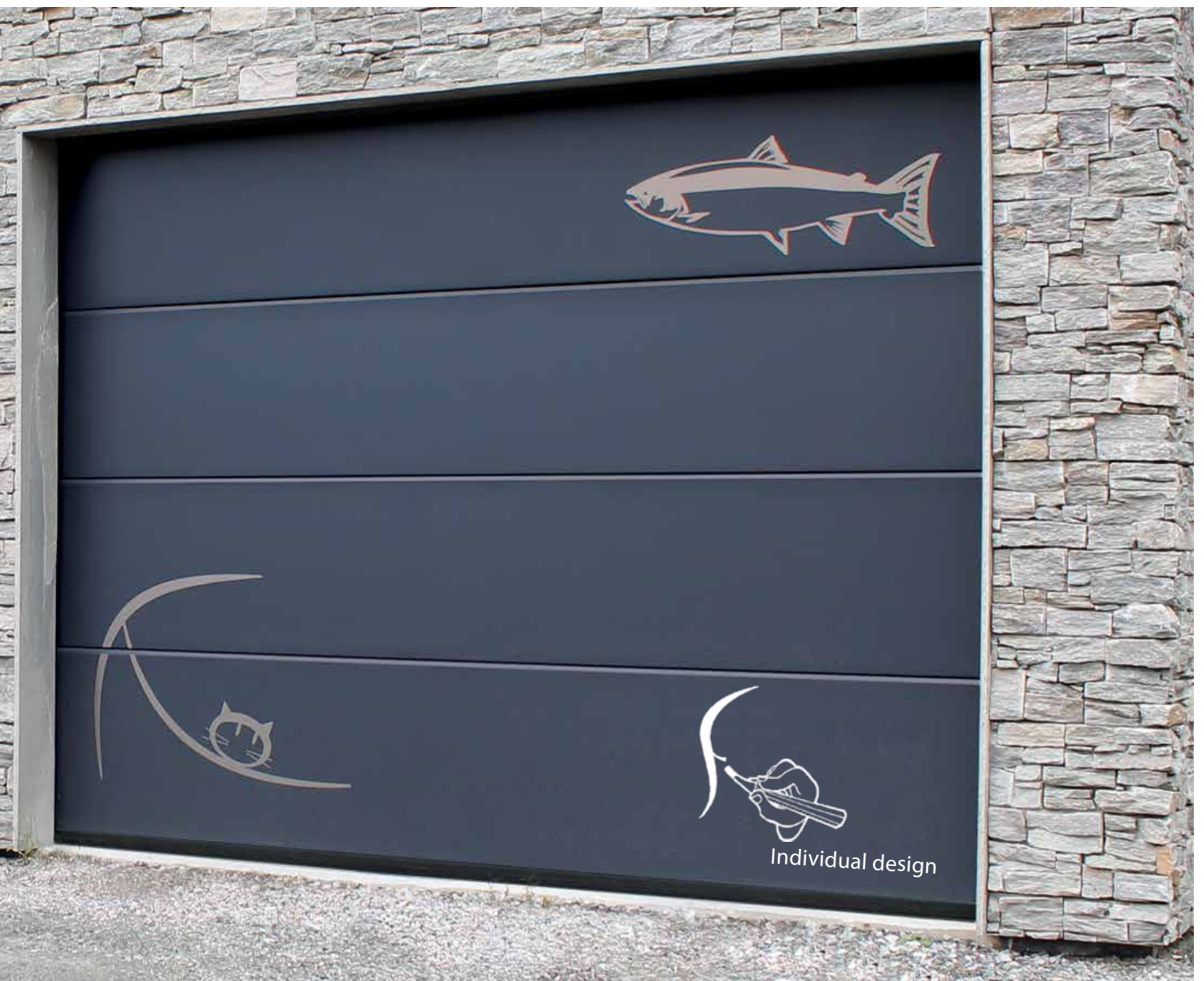



Full vision panels

Full vision panels can be coated in any RAL colour or in Golden Oak finish.

Acrylic double glazed windows come in a clear, matt, 'frosted' or tinted finish and perforated steel.

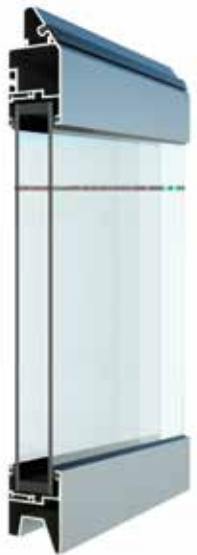

clear

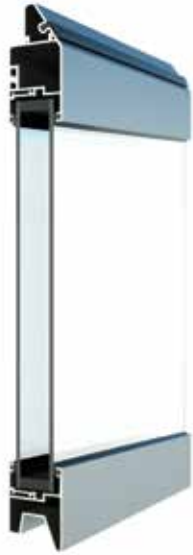

matt



'frosted'



tinted



perforated steel



Stainless steel windows

Using stainless steel windows from our stainless design range will give your garage door a contemporary and unique appearance. Use our recommended designs or create your own.



MAXI 315 x 315 mm
MIDI 235 x 235 mm
MINI 155 x 155 mm



MAXI 315 mm
MIDI 235 mm
MINI 155 mm

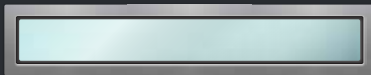

805 x 155 mm



PVC window with double glazing

A range of windows and decorative inserts are offered to add distinction to any home. Acrylic window frames and inserts can be painted to match your door or existing colours on your house.





1



A safe and reliable track system. Tracks are zinc coated as a standard, but they also can be powder coated in almost any colour.

2

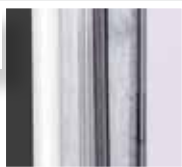

Whole perimeter rubber sealing makes the door energy efficient.

3



4



5



6



7



Hardware type R40

R40 sectional doors are customer and installer friendly. Requires minimum headroom and sideroom and is a perfect choice for new-built houses as well as renovated ones.

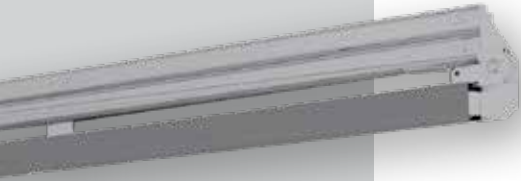

Tension spring system can be fitted on side, top or under the tracks. 4 spring system ensures safe and reliable operation.

Ball bearing rollers. Nylon coated rollers guarantee longer service and quiet operation.

Finger protection. Anti-pinching panels guarantee safe operation.

Side hinges with an adjustable roller carrier ensure the most efficient performance.

A convenient internal handle is located at the bottom corner and is very useful in case of manual operation.



R40-TM



R40-SM



R40-UM

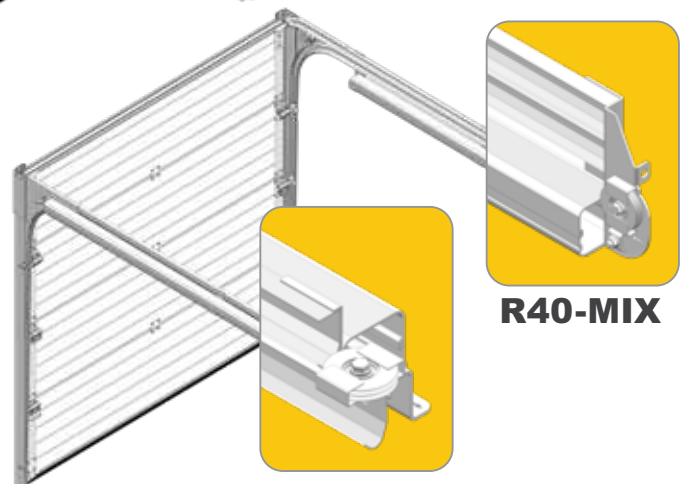

R40-MIX



1

Safe and reliable track system. Industrial grade tracks are designed for reliable and secure operation.



2

Whole perimeter rubber sealing makes the door energy efficient.



3



4



5

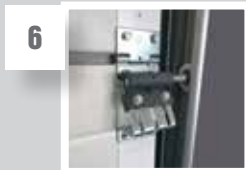

6



7

Hardware type TL

Components of our sectional garage doors have been developed and tested under the most demanding industrial conditions. Over decades of operations we have perfected every detail of our doors. We call it Intelligent Quality Control and it is a continuous process.



Torsion spring system expands possibility to build door up to 12 metres wide with smooth and reliable operation.

Ball bearing rollers. Nylon coated rollers guarantee longer service and quiet operation.

Finger protection. Anti-pinching panels guarantee safe operation.

Side hinges with an adjustable roller carrier ensure the most efficient performance.

A convenient internal handle is located at the bottom corner and is very useful in case of manual operation.

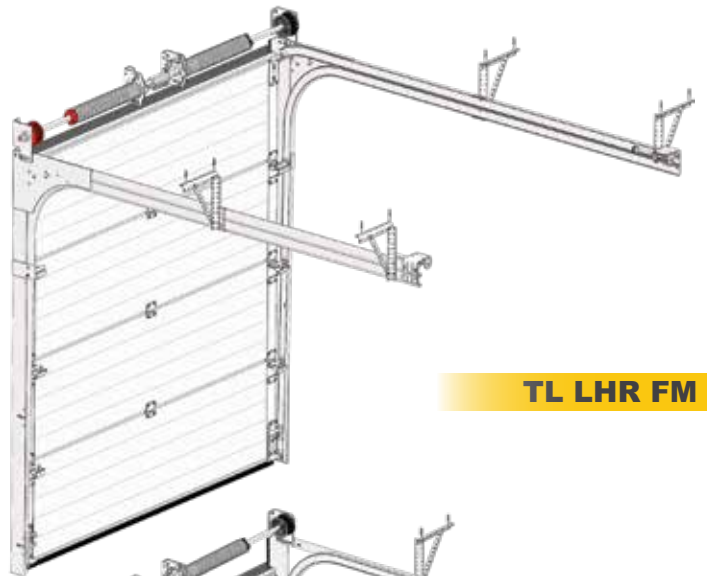

TL LHR FM

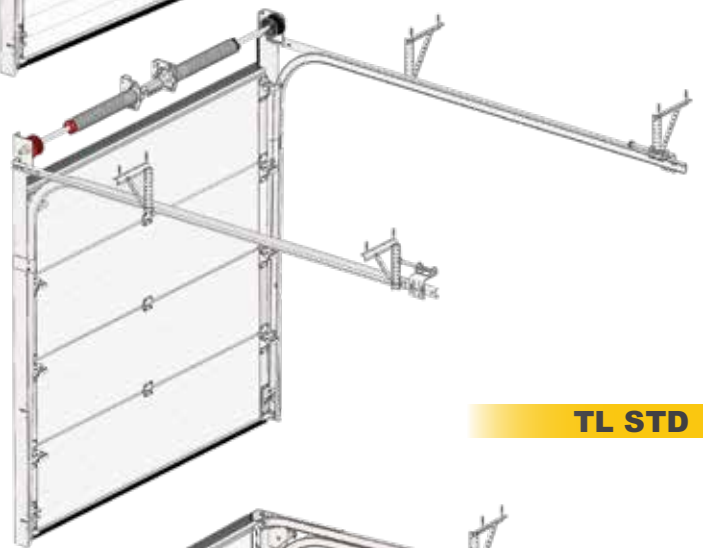

TL STD

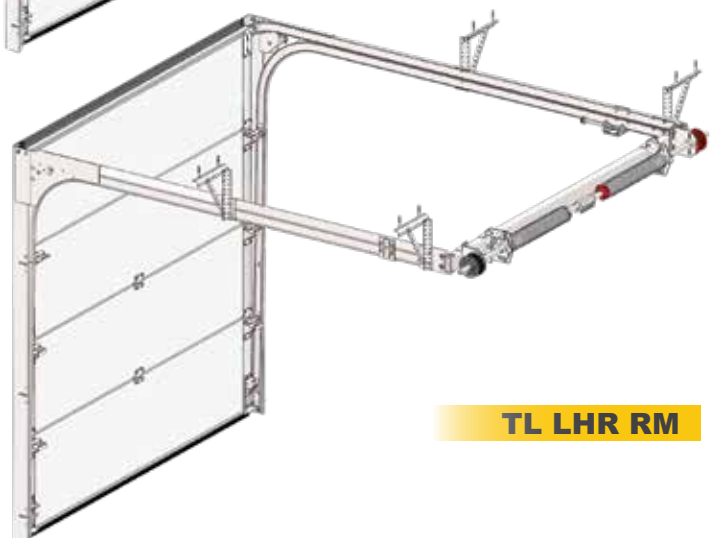

TL LHR RM

Fascia panels and frames



Vertical fascia panel



Horizontal fascia panel



ALU Lintel profile only.
120 mm; 180 mm.



Aluminum framing profile
85x40x40 mm



ALU frame (front installation)
Lintel + post.
Lintel 120 mm (suitable for LHR RM and R40).
Lintel 180 mm (suitable for LHR FM).
Posts 100 mm.



ALU frame with moulding



Accessories

Most of our doors are electrically operated, but for those that will be used manually Ryterna offers lock and handle kits.



UNIVERSAL LOCK



KNOB LOCK



KNOB HANDLE



LOCK IN STAINLESS STEEL FINISH



INTEGRATED MAIL BOX



INTEGRATED MAIL BOX



UNIVERSAL HANDLE



RAL PAINTED VENTILATION GRILL



PET FLAP



Door hardware (tracks, hinges, brackets) can be powder coated in white or almost any other RAL colour.



The Side Sliding Sectional Door



Other painted colours similar to RAL palette



RAL 9016 woodgrain



RAL 9016 stucco



RAL 9016 smooth

Types of door sections:

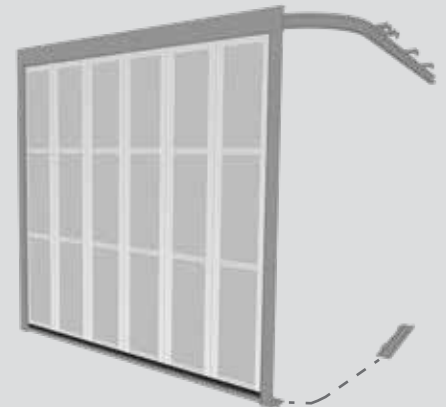

- Outstanding look in combination with perfect performance and low maintainance.
- Plenty of design options - including windows, stainless metal appliques.
- Aluminium hardware can be powder coated to match your garage interior.

- Low profile threshold can be fixed right on the existing garage floor.
- All perimeter brush sealing.
- Compatible with almost all electric operators.



Hardware type SSD

The Side Sliding Sectional Door





1



Optional electric operator for your additional convenience.

2



Optional special lock for a manually operated sliding door.

3



Brush seals along all perimeter.

4



Ball bearing rollers, heavy duty carriages and solid rails designed for doors up to 30 square metres.

5



Low profile threshold can be fixed on the existing floor – easy to fit and no maintenance required.

CUSTOM MADE DOORS



Garage door and fascia panel clad with 50x50 mm larch scantlings.



11 metres wide sectional garage door clad with green-copper tin.



Facade flush sectional doors give a possibility to conceal garage doors.



Facade-flush garage door clad with oak planks same as part of house facade to get 'concealed' door effect.

NON-STANDARD SOLUTIONS



Garage door clad with okoume and custom carved pattern.



Door clad with okoume. Glazed panel with 'cross' arched decor and dummy rivets to create 'medieval' image.



18 mm okoume plywood cladding milled to recreate the specific door design according to conservation area regulations.



Custom applique with company logo.



Stainless steel appliques according to architect's design.

MATCHING DESIGN





Customised 'Modern' design side-hinged door.



Side-hinged garage door clad with okoume plywood and custom size windows.



Side-hinged garage door clad with 18 mm thick okoume plywood.



Side-sliding door with custom windows, letter box and 80% gloss finish.



Side sliding door clad with okoume plywood.



Side-sliding door clad with corten panels.



